

PROFESSIONAL MEASURING OF CO₂

Professional measurement of concentrations up to 50 000 ppm



SAFETY

CONCENTRATION AND REST

HEALTH

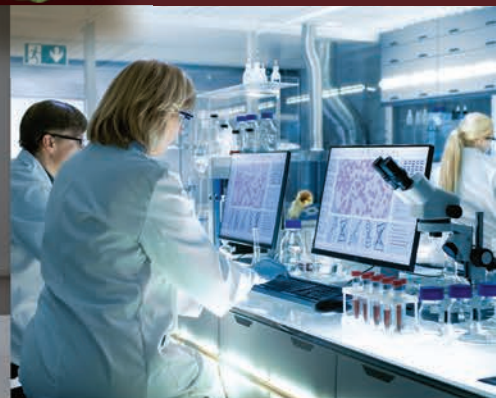

- Measuring
- Recording
- Online monitoring
- Regulation
- Warning alerts



OMET
since 1991

Why measure CO₂ concentration?

Health, concentration and rest

Carbon dioxide CO₂ is an integral part of the air we breathe. With each of our exhalations, its concentration in an enclosed space increases. This fact affects the state of our concentration, concentration, quality of sleep and the feeling of fatigue. Everyone knows a doctor's stuffy waiting room or a school classroom, where we could suddenly faint. These bodily feelings are evoked by the increased concentration of carbon dioxide, which has an adverse effect on our health and which we are exposed to almost every day while staying in closed rooms. Carbon dioxide is only a marker for us, ie. that its increased concentration indicates that the air would need to be replaced. Ventilation is good for our health. It is not just about carbon dioxide concentrations but also about air humidity and the presence of other harmful substances, viruses and bacteria.

Concentration [ppm]	Effects
approx. 350	outdoor level
up to 1000	recommended indoor level of CO ₂
1200-1500	recommended maximum indoor CO ₂
1500-2000	experience symptoms of fatigue and decreased concentration
2000-5000	possible headaches occur
5000	maximum safe concentration without health risks
> 5000	nausea and increased heart rate
> 15000	breathing difficulties
> 40000	possible loss of consciousness



Let in fresh and healthy air

Carbon dioxide as an indicator of air quality and the need to replace the air that contains other harmful substances, viruses and bacteria.

Safety in an environment with the possible occurrence of high concentrations of CO₂

Neglecting proper ventilation is dangerous to human life, because the CO₂ displaces oxygen and causes danger of suffocation of people working in the basement during the fermentation of beer, wine or cider. Early warning through a suitable CO₂ meter or proper ventilation controlled by our products can help prevent damage to health and property.



As a precaution, at the time of wine fermentation, the old winemakers always had a lit candle on the floor in the cellar, which went out when the concentration of carbon dioxide increased dangerously.

How do we measure CO₂ concentration?

The measurement is based on the NDIR principle with dual wavelength, which automatically compensates for the aging process of the sensor. The sensor is dirt-resistant and provides maintenance-free operation with excellent long-term stability and the recommended recalibration interval is an amazing 5 years.

A multiple point CO₂ and temperature adjustment procedure leads to excellent CO₂ measurement accuracy over the entire temperature working range.

The company COMET System, s.r.o. manufactures CO₂ measuring instruments in many variants, designs and measuring ranges. These products are for simple applications, where it is necessary to know only the current value of CO₂, to more complex with the need to analyse the measured data or control complex applications.

Indication

Page 4 - 5

- Simple indication
- Dataloggers

Comprehensive analysis

Page 6 - 9

- IoT GSM data loggers
- Wifi sensors
- IoT sensor enabled by Sigfox

Control and analysis

Page 10 - 17

Sensor outputs:

- Relay
- 4 - 20 mA
- 0 - 10 V
- RS485/232 (ModBus RTU)
- Ethernet



High concentration of CO₂

Page 18 - 19



Equipment for simple indication CO₂ monitors

The T5000 monitor is designed to monitor of CO₂ concentration inside buildings, such as schools, conference halls, hospitals, cinemas and theatres. The device indicates CO₂ concentration level using three colour LEDs. CO₂ monitor U8415 also offers the possibility to be powered by battery. Robust design of the device is suitable for installation in very busy places such as schools, offices, warehouses, pharmacies ...

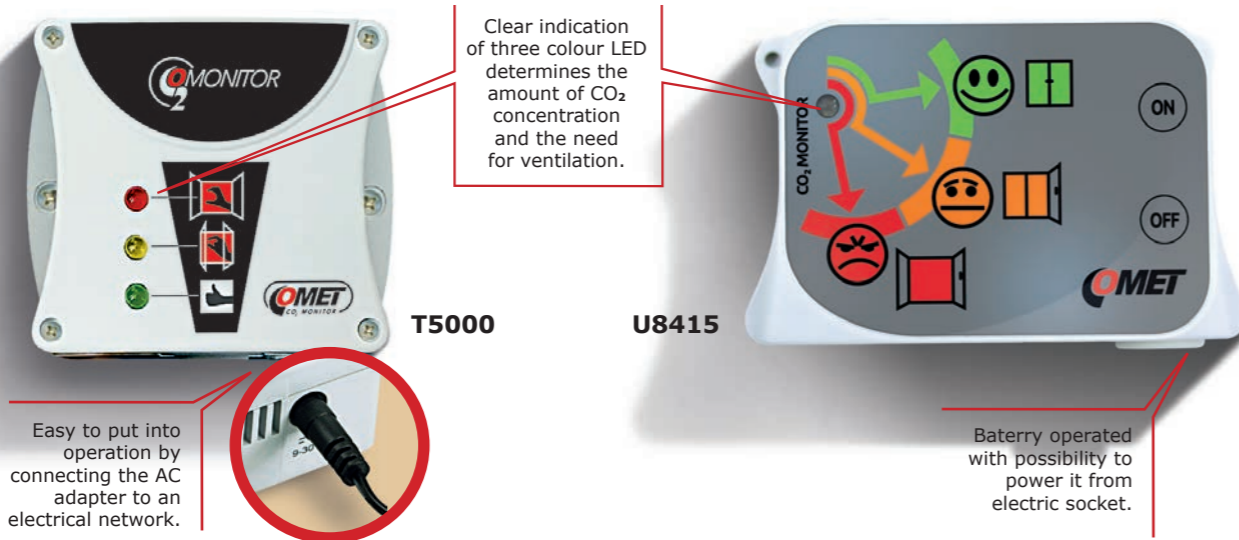

Equipment for simple indication and analysis Premium dataloggers for CO₂, temperature and humidity measuring and recording



Measured values		CO ₂			Temperature, relative humidity, CO ₂	Temperature, relative humidity, CO ₂ , bar. pressure	CO ₂ bar. pressure
model		T5000	U8415	U8410	U3430	U4440	U2422
temperature	range	-	-	-	-20 °C to +60 °C	-20 °C to +60 °C	-
	accuracy	-	-	-	±0.4 °C	±0.4 °C	-
relative humidity*	range	-	-	-	0 to 100 %RH	0 to 100 %RH	-
	accuracy **	-	-	-	±1.8% RH	±1.8% RH	-
dew point accuracy	accuracy ***	-	-	-	±1.5 °C	±1.5 °C	-
	accuracy ****	0 to 2000 ppm	0 to 5000 ppm	0 to 5000 ppm	0 to 5000 ppm	0 to 5000 ppm	according to the probe, length 1,2,4 m
CO ₂	accuracy	±(50ppm +2% MV)	±(50ppm +2% MV)	±(50ppm+2% MV)	±(50ppm+2% MV)	±(50ppm+2% MV)	-
	range	-	-	-	-	600 to 1100 hPa	600 to 1100 hPa
bar. pressure	accuracy at 23 °C	-	-	-	-	±1.3 hPa	±1.3 hPa
	typical battery life	no battery	up to 1 year				
class of protection of case with electronics		IP 20					

- 1200 to 2000/10 000 ppm
- 1000 to 1200 ppm
- 0 to 1000 ppm

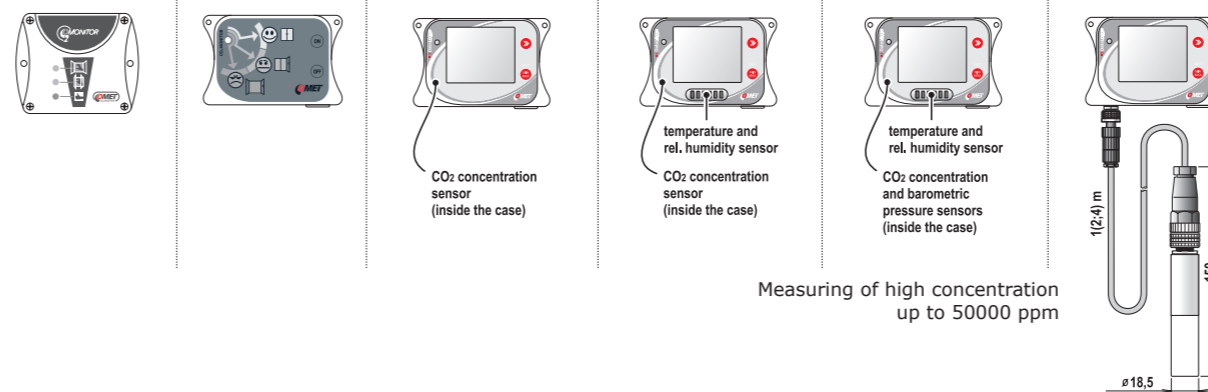

Measuring of high concentration up to 50000 ppm

External probe for U2422

SN220 - CO₂ external probe, range **0-10.000 ppm**; accuracy 100 ppm + 5 % from MV
SN223 - CO₂ external probe, range **0-50.000 ppm**; accuracy <± 1,5 % from range + 2 % from MV

* from 0 to 90 %RH at 23 °C
 ** accuracy of sensing element
 *** at ambient temperature T<25°C and RH>30%
 **** optional measuring range 10 000 ppm

Wireless sensors for comprehensive analysis

Comet System offers a fully automated complete wireless CO₂ monitoring solution. It is based on wifi, Sigfox, or GSM technology. Sensors with a wifi interface are especially suitable for indoor applications, while sensors and data loggers sending data via Sigfox or GSM wireless networks can also be used in outdoor applications. Your data for comprehensive analysis is easily collected in COMET Cloud.

COMET Cloud Measured data where you need it

COMET Cloud is the internet storage of data measured by COMET sensors. The data is accessible in the internet and displayed in an internet browser. Every user has the access to his account in the COMET Cloud which is protected by password. COMET Cloud enables to add sensors, creates organisational structures such sensor groups and user groups. The different rights can be set up for displaying and administration for each user.

Sensors with WiFi interface

Indoor applications

W4710

Backlit LCD display
WiFi antenna
LED light
USB-C connector for powering from external power supply 5 to 5.4 V DC

No limits for router selection
With **conventional communication** based on **2.4GHz IEEE 802.11b/g/n WiFi** radio



- unlimited space for data
- management and organization of
 - equipments
 - measured points
 - users and their access rights
- e-mail alarming when
 - exceeding alarm limits with the option define recipients according to the level of exceedance
 - a fault occurs (connection, measurement error)
- easy report creating
- device setup from COMET Cloud (only once a day)



- How to create account
- How to add device
- How to set role – administrator/user
- How to create measured place

Try GUEST access at <https://cometsystem.cloud/device/list>

IoT dataloggers with built-in GSM modem

U4440M

3-colour LED for alarm.
Large display for easier readability of current value, MIN/MAX value; alarm indication.
Two buttons keypad for device control.
Internal T/RH sensor.

Design with higher IP protection

IoT sensor powered by Sigfox network

IoT Sensor plus

Antenna.
Air intakes for CO₂ measurement (W8810).
Extra-long battery life.

The Sigfox network is used to transmit very short data messages and is optimized for low power consumption. It operates in the unlicensed radio band, which brings cheaper traffic, but also legislative restrictions - messages can not be sent faster than with a 10 minute interval. Operation is possible in Europe, Iran, Oman and South Africa (radio configuration zone is RC1). For current network deployment please see www.sigfox.com

Measured values			Sensors with WiFi interface		IoT sensor powered by Sigfox network			IoT dataloggers with built-in GSM modem	
			Temperature, relative humidity, CO ₂ , atm. Pressure	CO ₂	Temperature relative humidity CO ₂	Temperature, CO ₂		CO ₂	temp., humidity, CO ₂ , bar. pressure
Sensor model			W4710	W5714	W6810	W8810	W8861	U8410M	U4440M
temperature	internal	range	-30 to +60°C	-	-20 to +60 °C	-20 to +60 °C	-20 to +60 °C	-	-20 to +60°C
		accuracy	±0.4°C	-	±0.4 °C	±0.4 °C	±0.4 °C	-	±0.4°C
	external	range	-	-	0 to 95 %RH	-	-	-	-
		accuracy*	-	-	±1.8% RH **	-	-	-	-
relative humidity		range	0 to 95 % RH	-	-60 to +60 °C	-	-	-	0 to 100 % RH
		accuracy **	±1.8 %RH	-	0 to 500 0 ppm		according to the probe	-	±1.8 %RH
dew point accuracy		accuracy ***	±1.5 °C	-	± (50 ppm + 3 % of measured value)		-	±1.5 °C	
CO ₂		range****	0 to 5000 ppm	0 to 5000 ppm	-	-	600 to 1100 hPa	0 to 5000 ppm	0 to 5000 ppm
		accuracy	±(50ppm+3% MV)	±(50ppm+3% MV)	-	-	±1.3 hPa	±(50ppm+3% MV)	±(50ppm+3% MV)
atm. pressure		range	600 to 1100 hPa	-	NO	YES	YES	600 to 1100 hPa	600 to 1100 hPa
		accuracy	±1.3 hPa	-	YES	YES	NO	±1.3 hPa	±1.3 hPa
power supply			External power 5.0 to 5.4 VDC		Lithium battery External power 5.0 to 5.4 VDC		Lithium battery	Rechargeable accumulator External power 5.0 to 5.4 VDC	
IP protection class			IP30		IP20	IP20	IP54/ IP65	IP20	IP20



LP100 - Holder for mounting on magnetic surfaces
LP102 - Magnets for holder

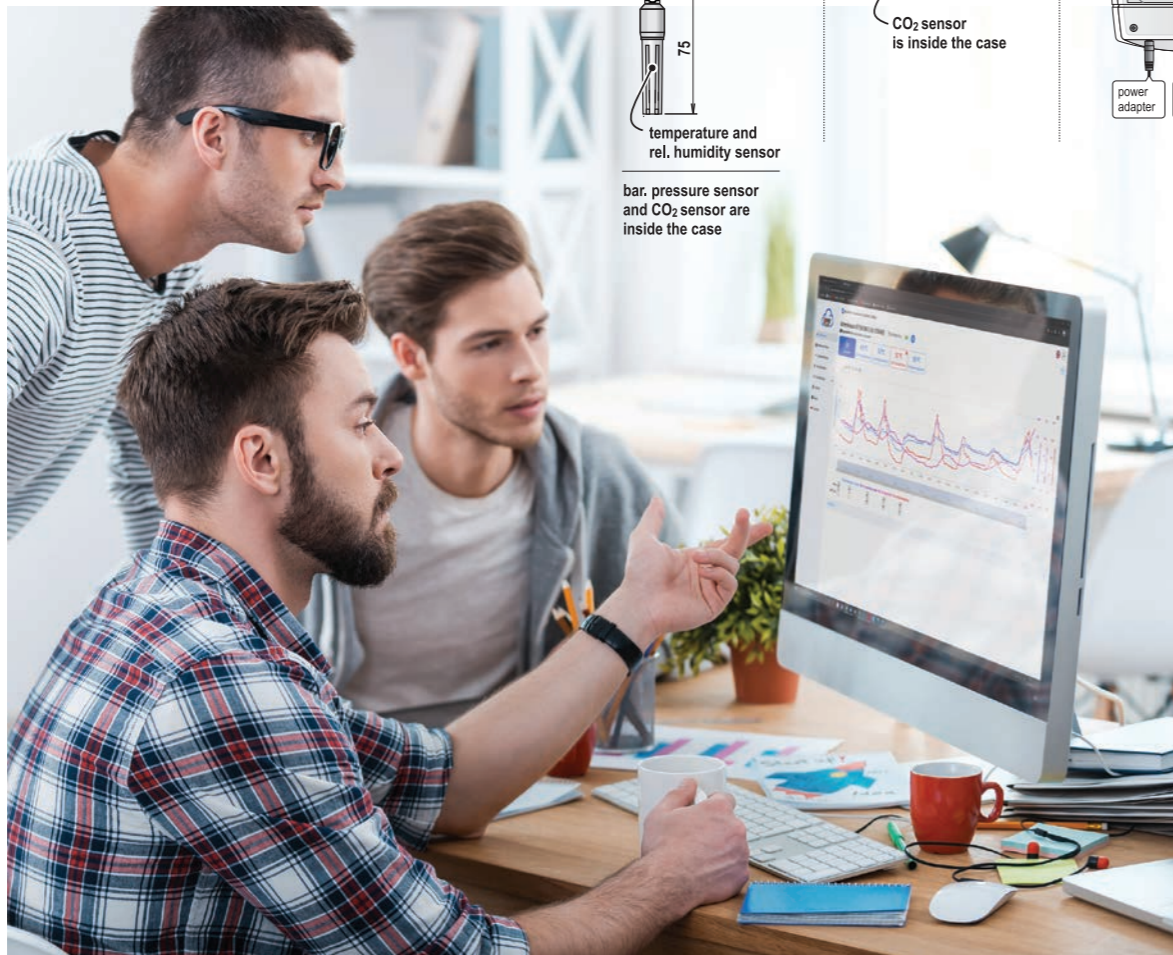
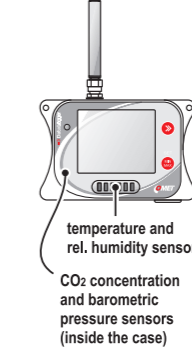
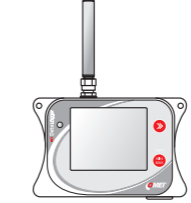
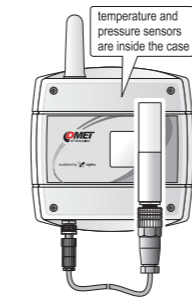
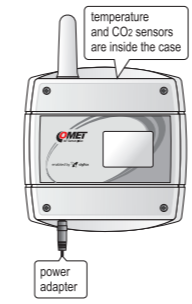
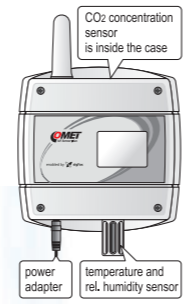
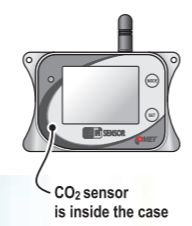
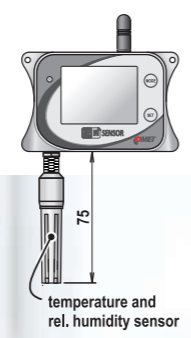

The Lifetime Fee built-in SIM card
Ready to use - everything is preset



IoT dataloggers
Internet of things operated by GSM network



COMET Cloud
Measured data where you need

- + The SIM card is already inserted in the datalogger
- + Logger's connectivity is available in all European countries
- + SIM card supports seamless coverage across national borders
- + The data is sent straight to COMET Cloud
- + Activated SIM card provides data volume of 500 MB, which can be used within 10 years
- does not support SMS text alarming

LP100 - wall holder with lock for IoT dataloggers or WiFi sensors

Control your application with CO₂ sensors

Comet System, s.r.o. is a producer of CO₂ sensors also in combination with temperature and humidity sensing parts for comprehensive measurement of quality of air in application where is the need for supervisory control and data acquisition (SCADA). The product is designed with various type of shapes for interior and industry application from simple wall mounting to mounting in an air duct. Sensors also differ in the output signal for data transmission.

The sensors can be divided into analogue and digital groups according to the output. All of them have adjustable measuring range.

Analogue output 4- 20 mA, 0 - 10 V

The most common analogue output is the current loop 4 - 20 mA, which is characteristic as a solution for considerable resistance against electromagnetic interference (often found in industry), long-distance transmission and its simplicity.



Duct mount CO₂ sensors for building automation.

Interior design with output 4 - 20 mA, 0 - 10 V

Interior sensors have all the advantages of T series sensors in industrial design. This is the same concept with a digital microprocessor. It differs by the type of housing which has been designed with regard to functional and attractive design. They are made for easy installation in a standard way into a flush-mounted wiring box.

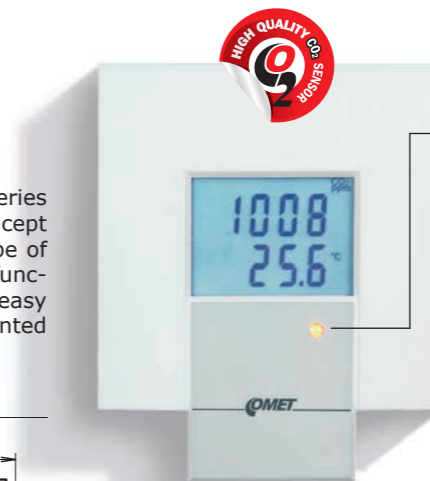
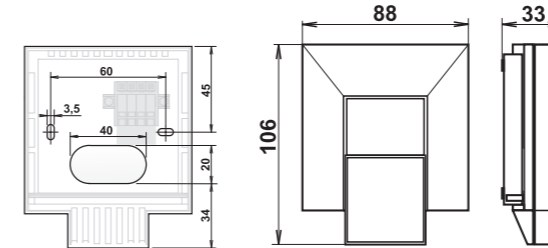

- 1200 to 2000/10 000 ppm
- 1000 to 1200 ppm
- 0 to 1000 ppm

Easy installation in a standard way into a flush-mounted wiring box. Minimal depth of the box is 40 mm.

Limits of LED indication may be changed by user.

T8148 - programmable sensor of temperature and CO₂

Measured values		Industry design			Interior
		CO ₂			Temperature + CO ₂
SENSOR MODEL	4 - 20 mA	T5141	T5140	T5145	T8148
	0 - 10 V	T5241	T5240	T5245	T8248
temperature	range	-	-	-	-10 to 50 °C
	accuracy	-	-	-	± 0,5 °C
CO ₂	range	0 to 10000 ppm	0 to 2000 ppm**	0 to 2000 ppm**	0 to 2000 ppm
	accuracy	± (110 ppm+2 % of measured value)	± (50 ppm+2% of measured value)	± (50 ppm+2% of measured value)	± (50 ppm+2% of measured value)
recommended calibration interval		five years	five years	five years	two years (temperature)/ five years (CO ₂)
protection class of the case with electronics		IP 65	IP 30	IP 30	IP 20
protection class of the sensors cover		IP 65	-	IP 20	-
temperature operating range of the case with electronics		-30 to +80 °C	-30 to +60 °C	-30 to +60 °C	0 to +50 °C
humidity operating range		0 to 100 %RH	5 to 95 %RH	5 to 95 %RH	0 to 100 % RH

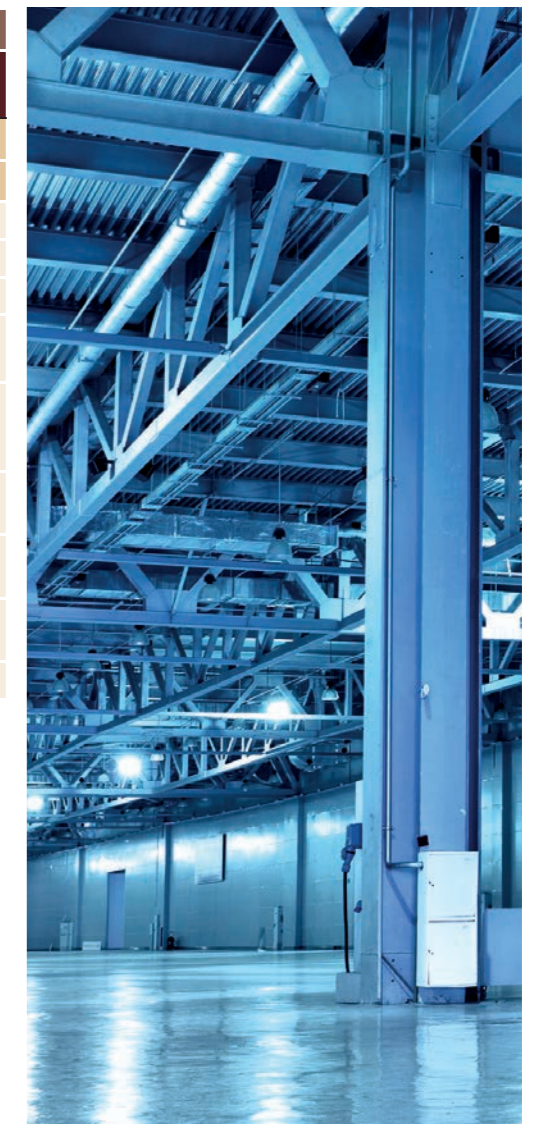
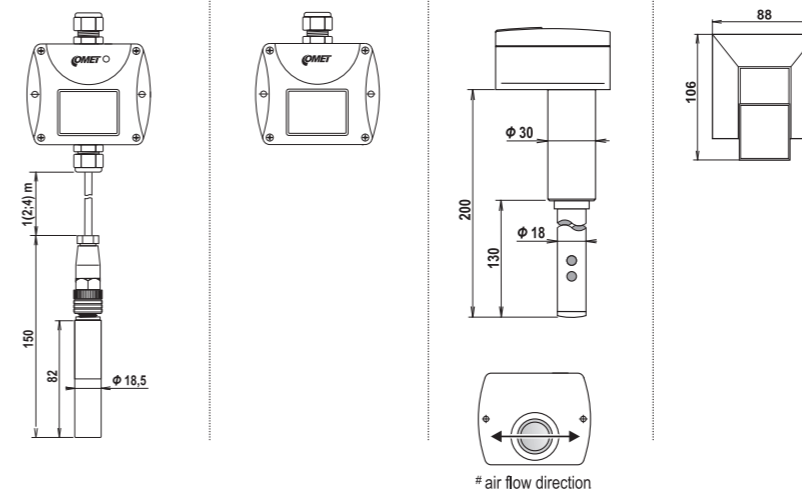

Serial output RS485/RS232, Relays

The sensors CO₂ with serial output are designed for industrial applications and also where interior design of sensor is preferred.



Some of CO₂ sensors (see table) are equipped with two relay outputs for alarm indication or control of external devices. Each relay can be assigned to any measured or computed value and comparing limit, delay, hysteresis and audible alarm can be set up. Regulators are made with the power relay output 50V/2A. Devices can be only with relay output or can be equipped with a serial output RS485 or RS232.

Transmitter circuitry is galvanically isolated from power circuitry to prevent collision in RS485 network. Serial output RS232 is not galvanically isolated. The transmitter works with ModBus RTU communication protocol or with Advantech ADAM compatible protocol. Protocol is user selectable. Serial link enables to read actual readings and modify transmitter configuration. Instrument works always in slave mode, i.e. responds only to master device query.

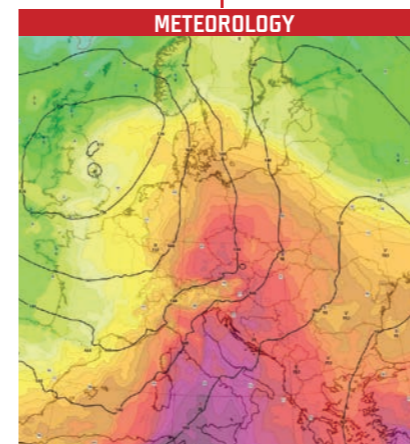

Measured values		Industry design						Interior design
		Temperature + relative humidity + CO ₂			CO ₂			Temperature + CO ₂
SENSOR MODEL WITH	RS485	H6320	H5421	T6440	H5424	T5441	T5440	T8448
	RS232	H6420	H5321	T6340	H5324	T5341	T5340	-
	No communication	H6020	H5021	-	H5024	-	-	-
temperature	range	-30 to +80 °C	-	-30 to +80 °C	-	-	-	-10 to +50 °C
	accuracy	±0,4 °C	-	±0,4 °C	-	-	-	±0,5 °C
relative humidity	range	0 to 100 % RH	-	0 to 100 % RH	-	-	-	-
	accuracy in range of 5 to 95 % at 23 °C	±2,5 % RH	-	±2,5 % RH	-	-	-	-
CO ₂	range	0 to 2000 ppm*	0 to 10000 ppm	0 to 2000 ppm*	0 to 2000 ppm*	0 to 10000 ppm	0 to 2000 ppm*	0 to 2000 ppm*
	accuracy at 25 °C and pressure of 1013 hPa	± (50 ppm + 2% of measured value)	± (10000 ppm + 5% of measured value)	± (50 ppm + 2% of measured value)	± (50 ppm + 2% of measured value)	± (10000 ppm + 5% of measured value)	± (50 ppm + 2% of measured value)	± (50 ppm + 2% of measured value)
2x relay outputs (2 A / max. power 60 VA)		YES	YES	NO	YES	NO	NO	NO
protection class - case with electronics / measuring end of stem / CO ₂ probe / RH + T probe		IP30/IP40/ - / - /	IP65/ - /IP65/ - /	IP30/IP40/ - / - /	IP30/ - / - / - /	IP65/ - /IP65/ - /	IP30/ - / - / - /	IP20/ - / - / - /
temperature operating range of the case with electronics		-30 to +60 °C	-30 to +80 °C	-30 to +60 °C	-30 to +60 °C	-30 to +80 °C	-30 to +60 °C	-10 to +50 °C
humidity operating range without condensation		5 to 95 % RH	0 to 100 % RH	5 to 95 % RH	5 to 95 % RH	0 to 100 % RH	5 to 95 % RH	5 to 95 % RH

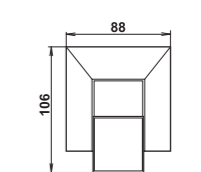
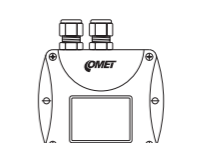
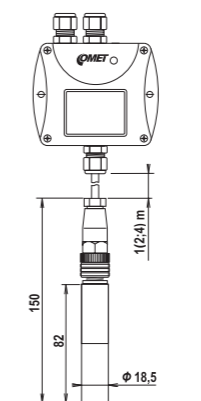
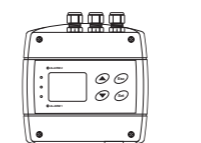
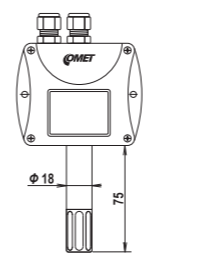
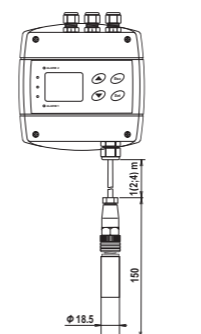
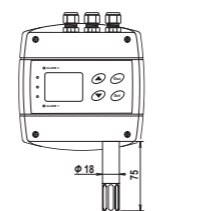

* Custom range 10 000 ppm for extra fee. Accuracy ± (100 ppm+5 % of measured value).

Ethernet output

Continuous monitoring of critical parameters can be very easily done by the help of Web Sensors. Measured values are accessible via a powerful embedded web server which is accessible from personal computer or mobile devices like smartphones and tablets. History values can be exported for further processing by the CSV file. The advantage of Web Sensors is possibility to provide settings via web interface. The sensors can be integrated into the control systems of different manufacturers using SNMP, MODBUS TCP, SOAP, syslog. Of course data in many formats is also available, for example XML and so on.

On-line measurement and monitoring

Current measured values are available on-line directly on a web browser from anywhere, all you need to do is enter the IP address. Alarms are indicated by a red field.

Graphs of actual values can also be displayed through a web browser. You can display up to one thousand measured values.

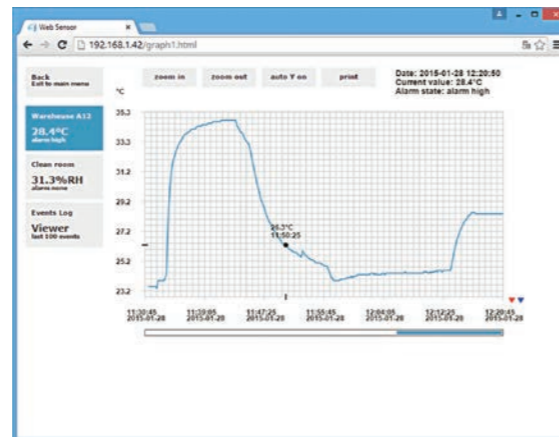
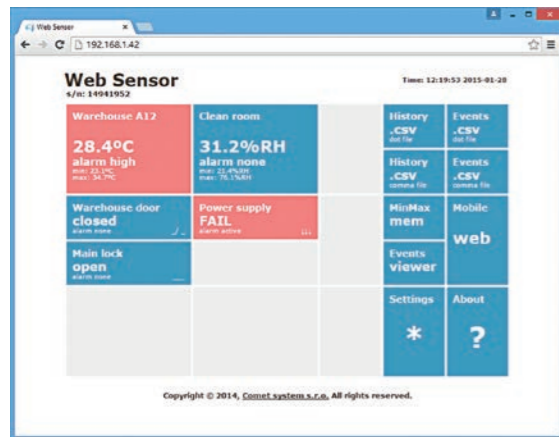

For each measurement channel upper and lower limit can be set. In case the limits are exceeded this alarm is indicated.

Modern HTML5 canvas graphic component allows to use graphs from thousands of devices. It is not a problem to show graphs on tablets or smartphones. All modern web browsers are supported - Firefox, Opera, Chrome or Microsoft Edge.

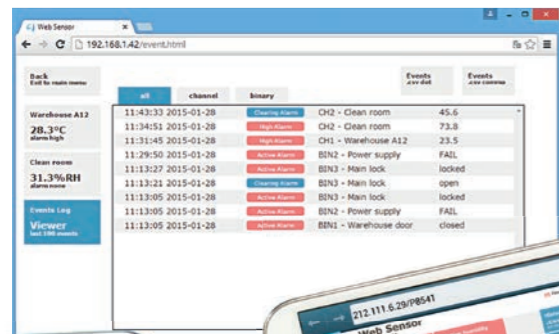

Minimum, maximum and alarm values together with a time stamp are recorded by the Event Log.



Alarms are indicated by a red field.

Device settings

Sensor settings can also be done directly in a web browser in your PC, smartphone or tablet. All you need to do is enter the IP address of the sensor, open Settings and set up everything from communication to alarm e-mails.

Configuration of the alarm e-mails. Device can send warning e-mail when alarm on measured channel occurs. E-mail is also sent when alarm condition is cleared.

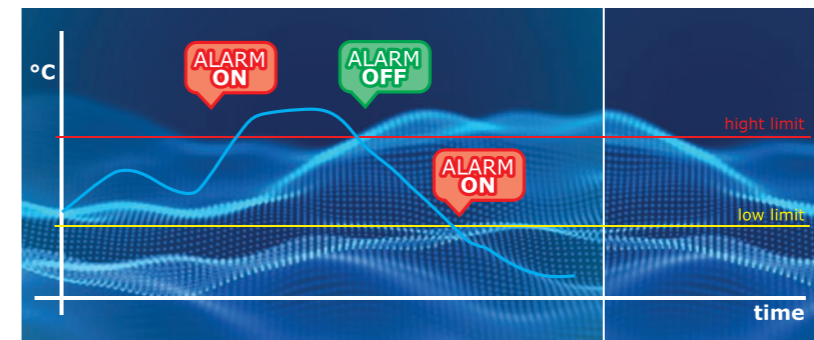
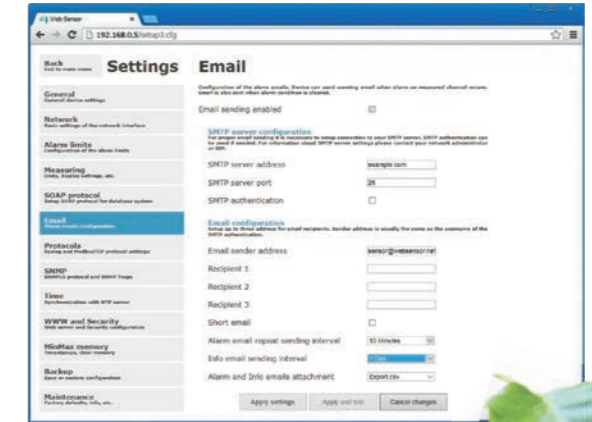
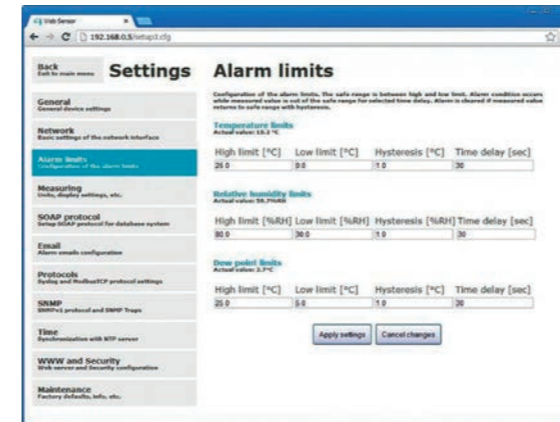

Ethernet RJ45 connector for cable connection.

Connector for power adapter with output voltage 9-30 Vdc.

Two relays for alarm indication or control of external devices. Each relay can be assigned to any measured value. The relay can also be controlled remotely via the communication protocol ModbusTCP.

- 0 to 1000 ppm
- 1000 to 1200 ppm
- 1200 to 2000/10 000 ppm
- Limits of LED indication may be changed by user

CO₂ module

Air intakes for CO₂ measurement.

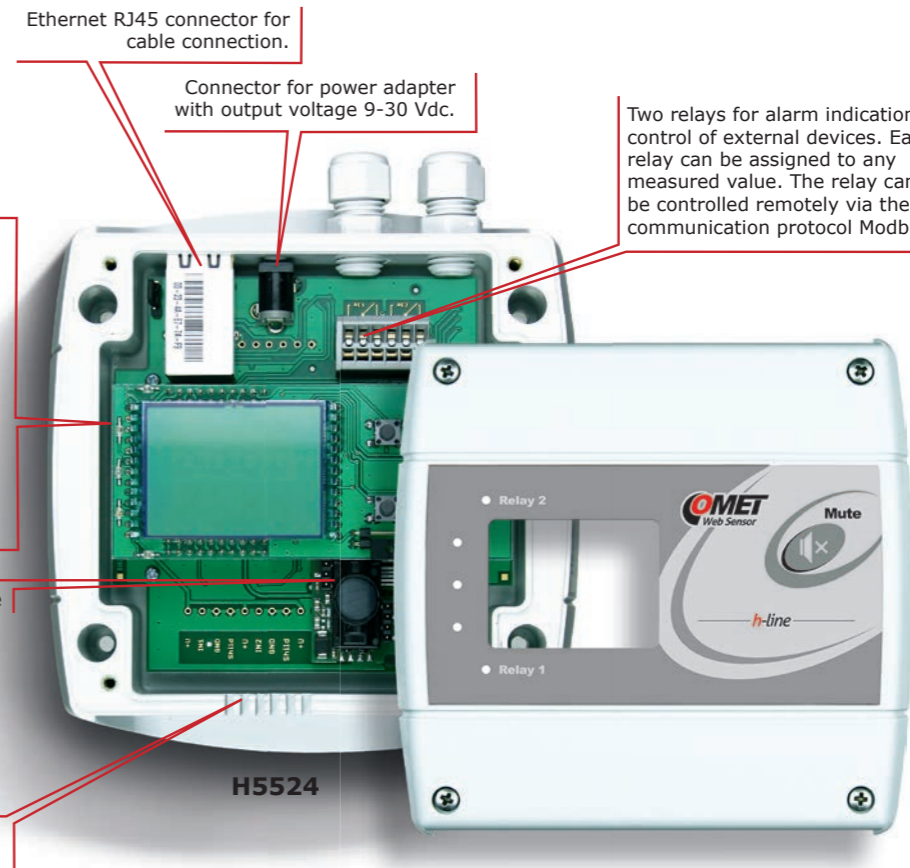

Measured values		Temperature + relative humidity + CO ₂			CO ₂							
No communication		T6540	T6640	T6641	H6520	T5540	T5541	T5545	T5640	T5641	H5524	H5521
temperature	range	-30 to +80 °C	-30 to +125 °C	-30 to +80 °C	-	-	-	-10 to +50 °C	-	-	-	-
	accuracy	±0,4 °C	±0,4 °C	±0,4 °C	-	-	-	±0,5 °C	-	-	-	-
relative humidity	range	0 to 100 % RH	0 to 100 % RH	0 to 100 % RH	-	-	-	-	-	-	-	-
	accuracy in range of 5 to 95 % at 23 °C	±2,5 % RH	±2,5 % RH	±2,5 % RH	-	-	-	-	-	-	-	-
CO ₂	range	0 to 2000 ppm*	0 to 10000 ppm	0 to 2000 ppm*	0 to 2000 ppm*	0 to 2000 ppm*	0 to 10000 ppm	0 to 2000 ppm*	0 to 2000 ppm*	0 to 10000 ppm	0 to 2000 ppm*	0 to 2000 ppm*
	accuracy at 25 °C and pressure of 1013 hPa	± (50 ppm + 2% of measured value)	± (10000 ppm + 5% of measured value)	± (50 ppm + 2% of measured value)	± (50 ppm + 2% of measured value)	± (50 ppm + 2% of measured value)	± (10000 ppm + 5% of measured value)	± (50 ppm + 2% of measured value)	± (50 ppm + 2% of measured value)	± (10000 ppm + 5% of measured value)	± (50 ppm + 2% of measured value)	± (50 ppm + 2% of measured value)
2x relay outputs (2 A / max. power 60 VA)		NO	NO	NO	YES	NO	NO	NO	NO	NO	YES	YES
power over Ethernet (PoE) according to IEEE 802.3af		NO	YES	YES	NO	NO	NO	NO	YES	YES	NO	NO
protection class - case with electronics / measuring end of stem / CO ₂ probe / RH + T probe		IP30/IP40 / - / - /	IP30/IP40 / - / - /	IP30 / - / IP65/IP40 /	IP30 / IP40 / - / - /	IP30 / - / - / - /	IP30 / - / IP65 / - /	IP30 / - / IP20 / - /	IP30 / - / - / - /	IP30 / - / IP65 / - /	IP30 / - / - / - /	IP30 / - / IP65 / - /

Device communication

By connecting directly to a computer network the thermometer or humidity meter can be integrated into the control systems of different manufacturers using SNMP, MODBUS TCP, SOAP, syslog. Of course data in many formats is also available, for example XML and so on.

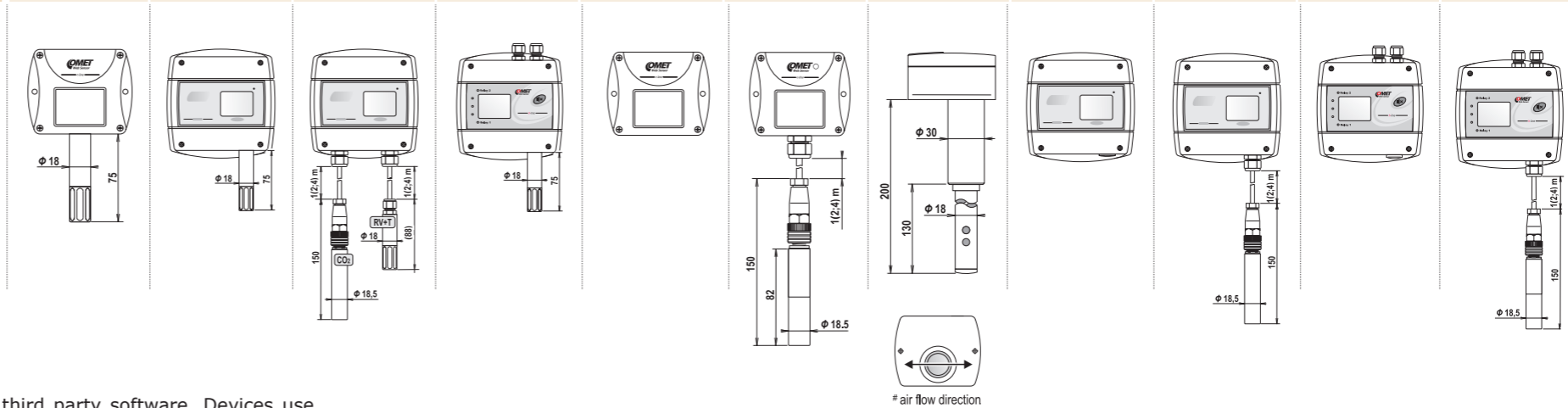

ModbusTCP protocol

Modbus protocol for communication with SCADA systems or third party software. Devices use Modbus TCP protocol version. Two Modbus clients can be connected to the device at one moment.



Actual values via XML

XML protocol for actual measured values reading. This protocol is suitable for Web Sensors integration into 3rd party SCADA systems.



SNMP protocol

SNMP version 1 protocol for IT infrastructure. Using SNMP protocol you can read actual measured values, alarm statuses and alarm parameters. Via SNMP protocol is also possible to get last 1000 measured values from the history table. MIB tables with OID description are available.



SNMP Trap

SNMP Trap for IT infrastructure. Web Sensors allow sending Traps to selected Trap receiver server. Traps are sent in case of alarm on channel or at error states like unable to send e-mail, unable to deliver SOAP message, etc.



SOAP protocol

Web Sensors allow to send currently measured values via SOAP v1.1 protocol. The device sends values in XML format to the web server. The advantage of this protocol is that communication is initialized by the device side. Therefore it is not necessary to use port forwarding.



Syslog protocol

Syslog protocol for IT infrastructure monitoring systems. Web Sensors allow sending text messages to selected Syslog server. Messages are sent in case of alarm on channel or at error states like unable to send e-mail, unable to deliver SOAP message, etc.



SNTP protocol - time synchronization

Time synchronisation with SNTP server. Actual time is shown at web pages and is necessary for timestamps inside CSV files. Synchronisation interval can be set to one day or to one hour.



COMET Cloud also supports Web Sensors in addition to wifi, Sigfox, and GSM devices.

Mounting accessories for sensors with stem or external probe



PP90 – Right-angled stainless steel flange.



PP4 – plastic flat circular flange.



SP004 - Plastic gland for direct mounting of the humidity probe to a 29 mm diameter hole.

High concentration of CO₂

Reliably measures CO₂ concentration up to 5 % (50 000 ppm) in agriculture, life stock barns, hatchers, incubators, green houses or outdoors. The active pressure and temperature compensation with on-board sensors leads to best CO₂ measurement accuracy independently of the altitude or environmental conditions.

External probe of CO₂

Hand-held meter with interchangeable digital probes for accurate measurement of humidity, temperature, CO₂.

Range	0 to 10000 ppm	0 to 50000 ppm
Accuracy	± (110 ppm + 2 % of MV) at 23 °C and 1013 hPa	< ±(1,5 % from full scale +2% from the measured value) at 23 °C and 1013 hPa

Datalogger with interchangeable CO₂ probe.



CO₂ probe for high concentration + 3 inputs for temperature or temp/humidity probes.

Alarm indication by LEDs or graphical display.

Measured values are stored internally in non-volatile memory.

Battery and mains power supply.

Built-in audio alarm.

5V DC RS232 ALARM

LOG Memory 982 hPa 0.517 %



PROFESSIONAL MEASURING OF CO₂

Professional measuring of CO₂



The COMET System, s.r.o. company is continuously developing and improving its product. COMET System, s.r.o. reserves the right to carry out technical changes in equipment or product without any previous notice.

COMET SYSTEM, s.r.o.
Bezrucova 2901
756 61 Roznov pod Radhostem
CZECH REPUBLIC
Tel: +420-571653990
E-mail: info@cometsystem.com
www.cometsystem.com